

## KLT-A6MF-OV5640-1B V1.0

### 5MP OmniVision OV5640-1B MIPI-Schnittstelle M12 Fester Fokus Kameramodul



Vorderansicht



Rückansicht

#### Spezifikationen

<b>Kameramodul Nr.</b>	<b>KLT-A6MF-OV5640-1B V1.0</b>
<b>Auflösung</b>	5MP
<b>Bildsensor</b>	OV5640-1B
<b>Sensorart</b>	1/4"
<b>Pixel Größe</b>	1.4 um x 1.4 um
<b>EFL</b>	2.15 mm
<b>F.NO</b>	2.35
<b>Pixel</b>	2592 x 1944
<b>Betrachtungswinkel</b>	126.0°(DFOV) 111.0°(HFOV) 66.0°(VFOV)
<b>Linsenabmessungen</b>	13.00 x 13.00 x 14.02 mm
<b>Modulgröße</b>	126.50 x 22.00 mm
<b>Modultyp</b>	Fester Fokus
<b>Schnittstelle</b>	MIPI
<b>Autofokus-VCM-Treiber-IC</b>	Eingebettet
<b>Linsenmodell</b>	KLT-LENS-TRC-4047B1
<b>Linsentyp</b>	650 nm IR-Schnitt
<b>Betriebstemperatur</b>	-30°C to +70°C
<b>Gegenstecker</b>	AXT524124

**KLT-A6MF-OV5640-1B V1.0****5MP OmniVision OV5640-1B MIPI-Schnittstelle M12  
Fester Fokus Kameramodul**

Ansicht von oben

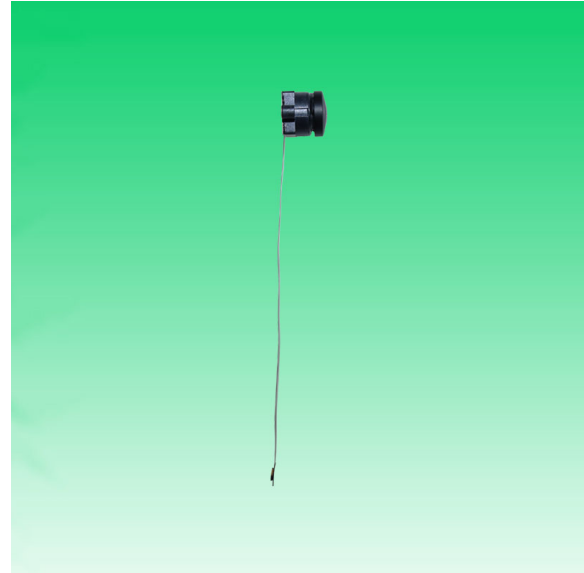

Seitenansicht



Untersicht



Gegenstecker



# CMOS CAMERA MODULES



*your BEST camera module partner*

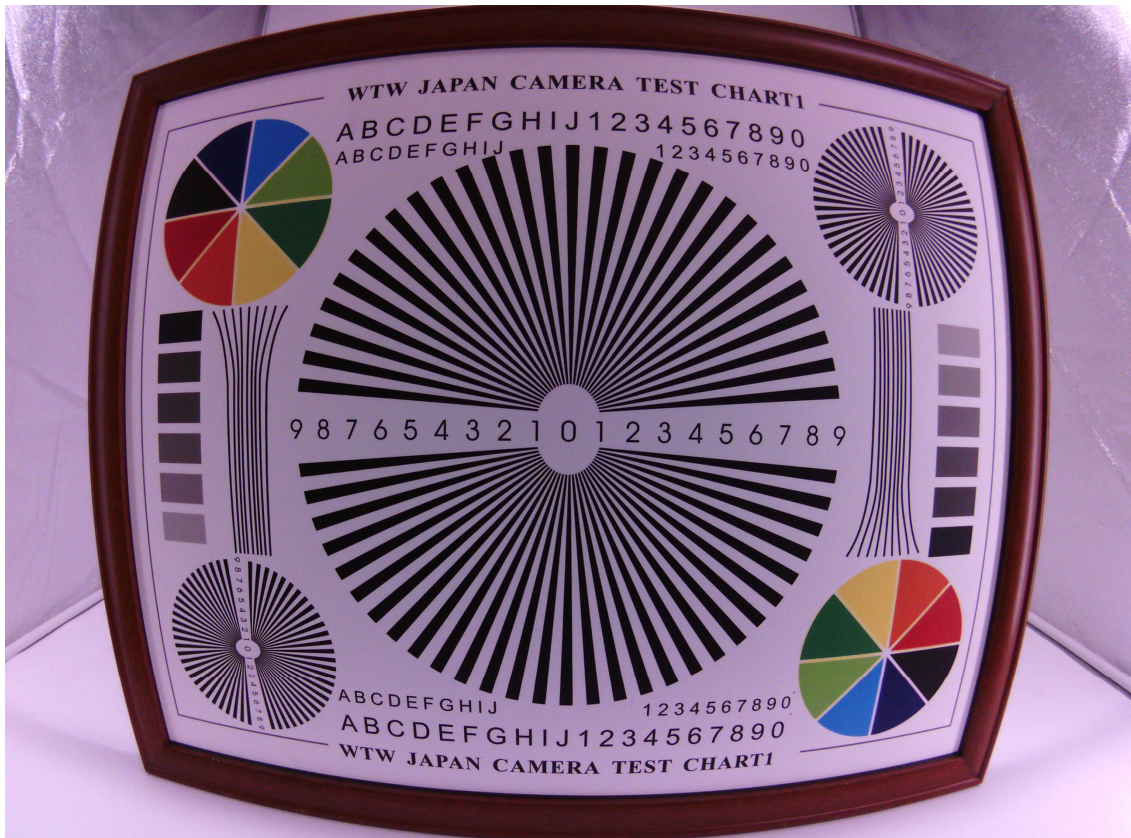

[www.KaiLapTech.com](http://www.KaiLapTech.com) [sales@KaiLapTech.com](mailto:sales@KaiLapTech.com) Tel: (852) 6908 1256 Fax: (852) 3017 6778

All rights reserved @ Kai Lap Technologies Group Ltd. Specifications subject to change without notice.



# CMOS CAMERA MODULES



*your BEST camera module partner*



[www.KaiLapTech.com](http://www.KaiLapTech.com) [sales@KaiLapTech.com](mailto:sales@KaiLapTech.com) Tel: (852) 6908 1256 Fax: (852) 3017 6778

All rights reserved @ Kai Lap Technologies Group Ltd. Specifications subject to change without notice.



your *BEST* camera module partner

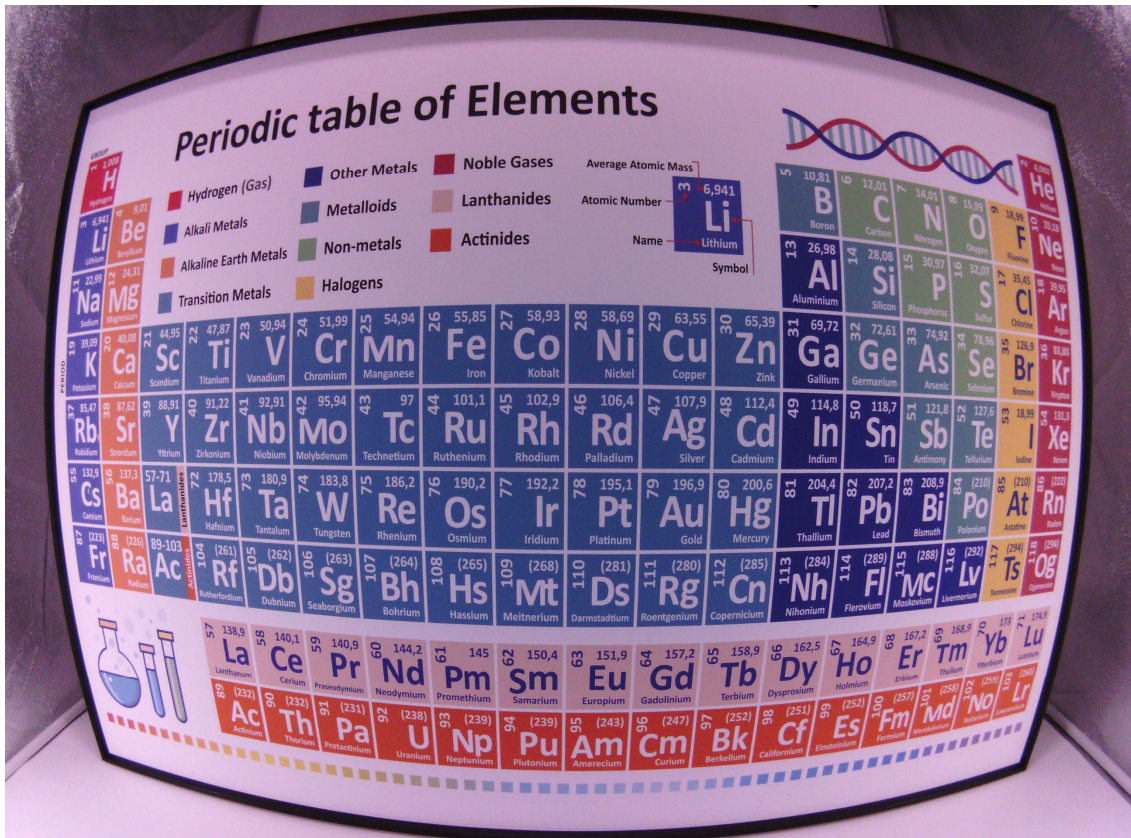

[www.KaiLapTech.com](http://www.KaiLapTech.com) [sales@KaiLapTech.com](mailto:sales@KaiLapTech.com) Tel: (852) 6908 1256 Fax: (852) 3017 6778

All rights reserved @ Kai Lap Technologies Group Ltd. Specifications subject to change without notice.

# ROHS

## PIN SIGNAL

1	NC
2	AVDD 2.8V
3	SCL
4	SDA
5	RESET
6	PWDN
7	DOVDD 1.8V
8	DVDD 1.5V
9	GND
10	XCLK
11	DGND
12	DGND
13	MDN1
14	MCN
15	MDP1
16	MCP
17	DGND
18	DGND
19	DGND
20	MDN0
21	DGND
22	MDP0
23	DGND
24	DGND

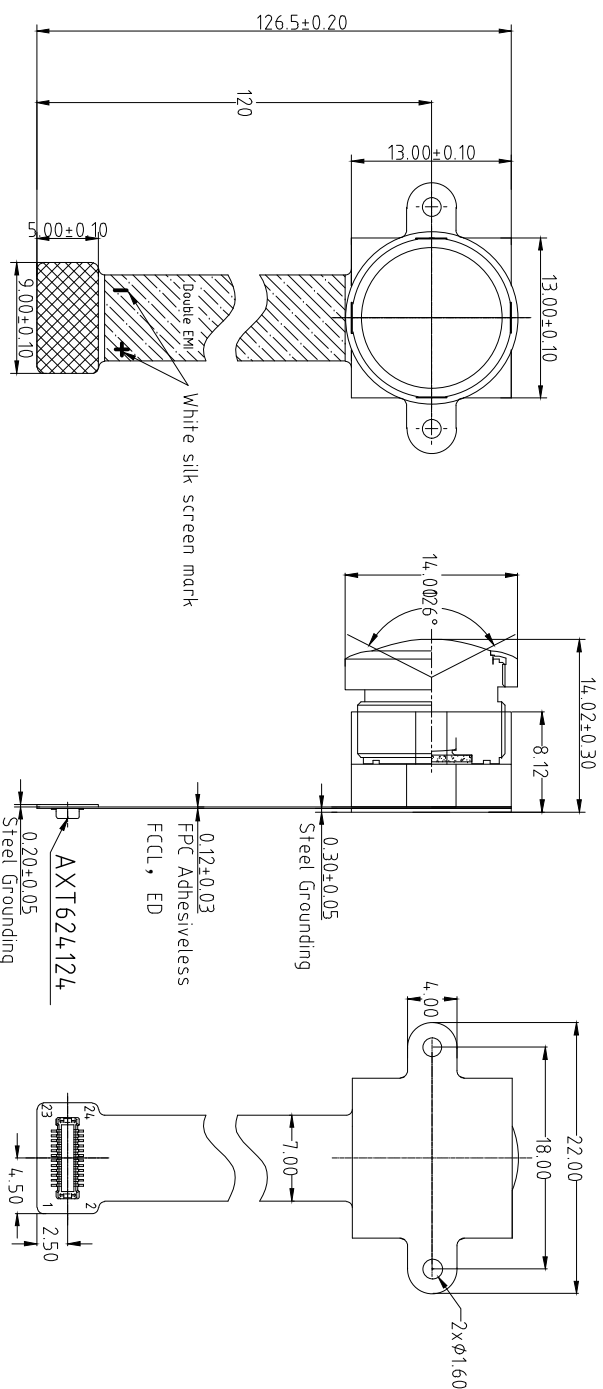
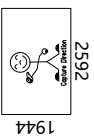

### Parameters:

#### 1、Sensor specification:

Image Sensor: OV5640-1B  
 Pixel: 1.4umx1.4um  
 Lens Type: 1/4  
 Important Voltage Description: DVDD1.5V (external power supply);

#### 2、Lens specification:

FOV: 126°(D),111°(H),66°(V)  
 F/NO: 2.35  
 TV distortion: <15.7%  
 Focal length: 2.15mm  
 Composition: 5G+IR FILTER  
 IR Cut Coating: 650nm±10nm@50%

Kai Lap Technologies Group Ltd

Designed By	Kevin	Model Name:	KLT-A6MF-OV5640-1B V1.0		
Checked By	Aouly__Yan	Projection Type	mm	Material:	-----
		Third Angle	Scale:	Sheet:	Version:
			1:1	1 of 1	1/0

Version	Information	Date
V1.0	First Version	9-30-2021



Lens Model: KLT-LENS-TRC-4047B1

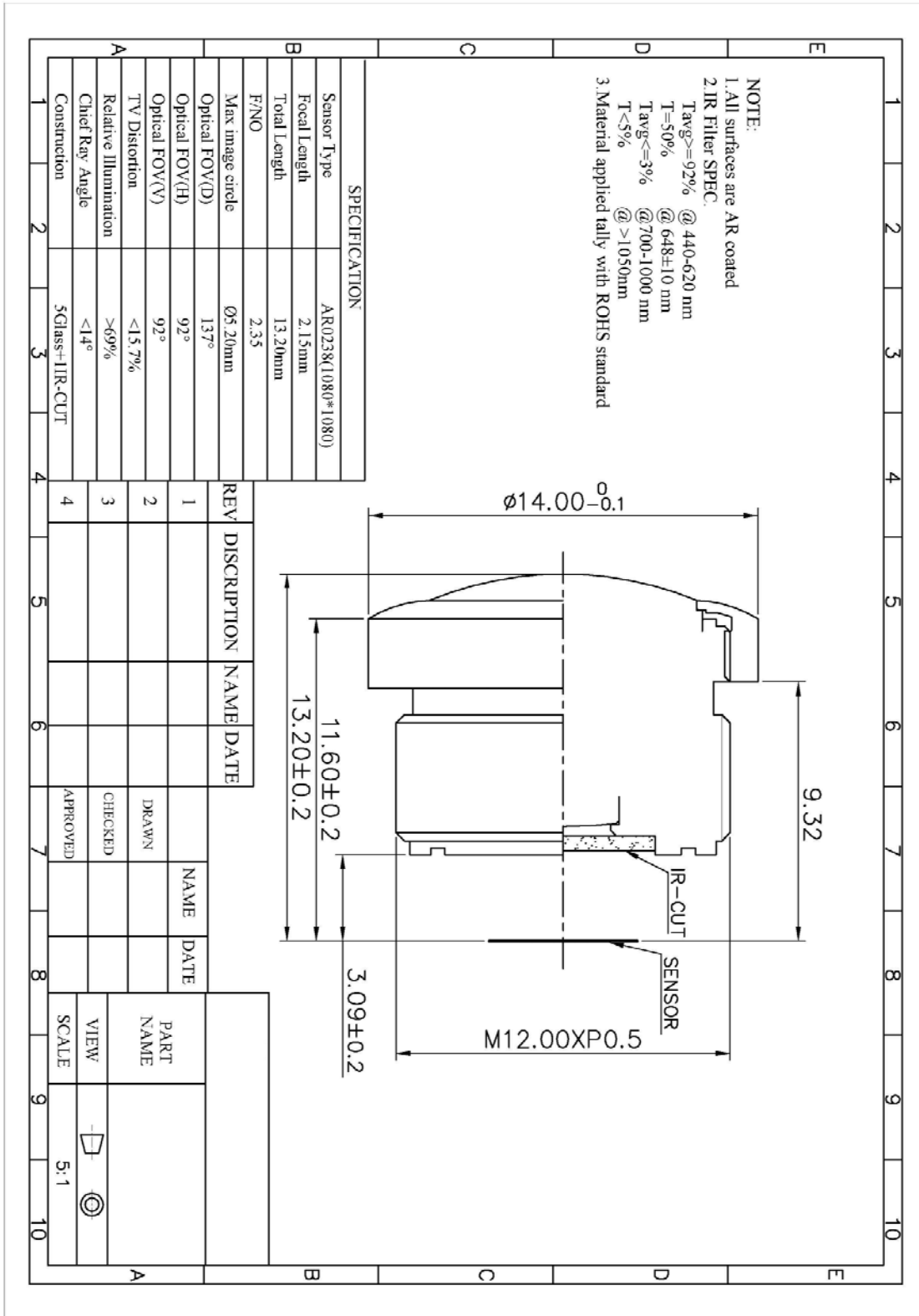

## NARROW-PITCH, THIN AND SLIM CONNECTOR FOR BOARD-TO-FPC CONNECTION

## NARROW PITCH (0.4 mm) CONNECTORS F4S SERIES

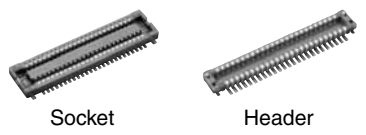

Compliance with RoHS Directive

### FEATURES

**1. Space-saving (3.6 mm widthwise)**  
The required space is smaller than our F4 series (40-contact type):

- Socket — 27% smaller,
- Header — 38% smaller

The small size contributes to the miniaturization of target equipment.

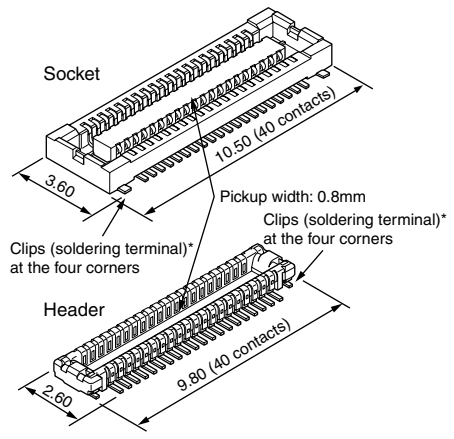

\* Clips for preventing the solder joints from being removed

**2. Highly reliable**  
**TOUGH CONTACT** has strong resistance to adverse environments.  
(See Page 6 for details of the structure)  
Note: If extra resistance to shock caused by dropping is required, we recommend using our previous F4 Series.

**3. The simple lock structure gives tactile feedback that ensures a superior mating/unmating operation feel.**

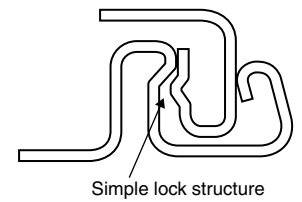

**4. Gull-wing type terminals**  
The gull-wing type terminals facilitate automatic mounting inspections.  
**5. Connectors for inspection available**  
Connectors for inspection are available that are ideal for modular unit inspection and inspection in device assembly processes.

### APPLICATIONS

Compact portable devices “Cellular phones, DVC, Digital cameras, etc”

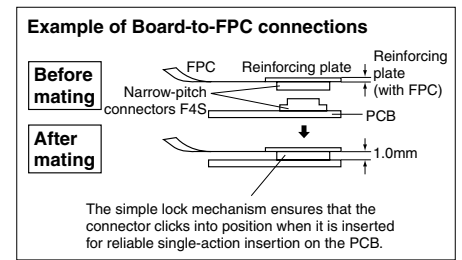

### ORDERING INFORMATION

AXT      **4**

5: Narrow Pitch Connector F4S (0.4 mm pitch) Socket  
6: Narrow Pitch Connector F4S (0.4 mm pitch) Header

Number of contacts (2 digits)

Mated height  
<Socket>  
1: For mated height 1.0 mm  
2: For mated height 1.2 mm  
<Header>  
1: For mated height 1.0 mm  
2: For mated height 1.2 mm

Functions  
<Socket, Header>  
2: Without positioning bosses

Surface treatment (Contact portion / Terminal portion)  
<Socket>  
4: Base: Ni plating Surface: Au plating (for Ni barrier available)  
<Header>  
4: Base: Ni plating Surface: Au plating

Note: Please note that models with a mated height of 1.0 mm (7th digit of part number is “1”) and 1.2 mm (7th digit of part number is “2”) are not compatible.

# AXT5, 6

## PRODUCT TYPES

Mated height	Number of contacts	Part number		Packing	
		Socket	Header	Inner carton	Outer carton
1.0mm	10	AXT510124	AXT610124	3,000 pieces	6,000 pieces
	12	AXT512124	AXT612124		
	14	AXT514124	AXT614124		
	16	AXT516124	AXT616124		
	18	AXT518124	AXT618124		
	20	AXT520124	AXT620124		
	22	AXT522124	AXT622124		
	24	AXT524124	AXT624124		
	26	AXT526124	AXT626124		
	28	AXT528124	AXT628124		
	30	AXT530124	AXT630124		
	32	AXT532124	AXT632124		
	34	AXT534124	AXT634124		
	36	AXT536124	AXT636124		
	38	AXT538124	AXT638124		
	40	AXT540124	AXT640124		
	42	AXT542124	AXT642124		
	44	AXT544124	AXT644124		
	46	AXT546124	AXT646124		
	48	AXT548124	AXT648124		
50	AXT550124	AXT650124			
54	AXT554124	AXT654124			
60	AXT560124	AXT660124			
64	AXT564124	AXT664124			
70	AXT570124	AXT670124			
80	AXT580124	AXT680124			
1.2mm	10	AXT510224	AXT610224		
	30	AXT530224	AXT630224		
	40	AXT540224	AXT640224		
	50	AXT550224	AXT650224		
	80	AXT580224	AXT680224		

- Notes: 1. Order unit: For mass production: in 1-inner-box (1-reel) units  
 Samples for mounting check: in 50-connector units. Please contact our sales office.  
 Samples: Small lot orders are possible. Please contact our sales office.
2. The above part numbers are for connectors without positioning bosses, which are standard. When ordering connectors with positioning bosses, please contact our sales office.
3. Please contact us for connectors having a number of contacts other than those listed above.

# SPECIFICATIONS

## 1. Characteristics

	Item	Specifications	Conditions
Electrical characteristics	Rated current	0.3A/contact (Max. 5 A at total contacts)	
	Rated voltage	60V AC/DC	
	Breakdown voltage	150V AC for 1 min.	No short-circuiting or damage at a detection current of 1 mA when the specified voltage is applied for one minute.
	Insulation resistance	Min. 1,000MΩ (initial)	Using 250V DC megger (applied for 1 min.)
	Contact resistance	Max. 90mΩ	Based on the contact resistance measurement method specified by JIS C 5402.
Mechanical characteristics	Composite insertion force	Max. 0.981N/contacts × contacts (initial)	
	Composite removal force	Min. 0.165N/contacts × contacts	
Environmental characteristics	Contact holding force (Socket contact)	Min. 0.49N/contacts	Measuring the maximum force. As the contact is axially pull out.
	Ambient temperature	-55°C to +85°C	No freezing at low temperatures. No dew condensation.
	Soldering heat resistance	Peak temperature: 260°C or less (on the surface of the PC board around the connector terminals) 300°C within 5 sec. 350°C within 3 sec.	Infrared reflow soldering Soldering iron
	Storage temperature	-55°C to +85°C (product only) -40°C to +50°C (emboss packing)	No freezing at low temperatures. No dew condensation.
	Thermal shock resistance (header and socket mated)	5 cycles, insulation resistance min. 100MΩ, contact resistance max. 90mΩ	Sequence 1. -55 <sup>±</sup> 3°C, 30 minutes 2. ~, Max. 5 minutes 3. 85 <sup>±</sup> 3°C, 30 minutes 4. ~, Max. 5 minutes
	Humidity resistance (header and socket mated)	120 hours, insulation resistance min. 100MΩ, contact resistance max. 90mΩ	Bath temperature 40±2°C, humidity 90 to 95% R.H.
	Saltwater spray resistance (header and socket mated)	24 hours, insulation resistance min. 100MΩ, contact resistance max. 90mΩ	Bath temperature 35±2°C, saltwater concentration 5±1%
	H <sub>2</sub> S resistance (header and socket mated)	48 hours, contact resistance max. 90mΩ	Bath temperature 40±2°C, gas concentration 3±1 ppm, humidity 75 to 80% R.H.
Lifetime characteristics	Insertion and removal life	50 times	Repeated insertion and removal speed of max. 200 times/hours
Unit weight		20-contact type: Socket: 0.03 g Header: 0.01 g	

## 2. Material and surface treatment

Part name	Material	Surface treatment
Molded portion	LCP resin (UL94V-0)	—
Contact and Post	Copper alloy	Contact portion: Base: Ni plating Surface: Au plating Terminal portion: Base: Ni plating Surface: Au plating (except the terminal tips) The socket terminals close to the portion to be soldered have nickel barriers (exposed nickel portions). Metal clips: Sockets: Base: Ni plating Surface: Pd+Au flash plating (except the terminal tips) Headers: Base: Ni plating Surface: Au plating (except the terminal tips)

# AXT5, 6

**DIMENSIONS** (Unit: mm) The CAD data of the products with a **CAD Data** mark can be downloaded from: <http://panasonic-electric-works.net/ac>

## Socket (Mated height: 1.0 mm and 1.2 mm)

**CAD Data**

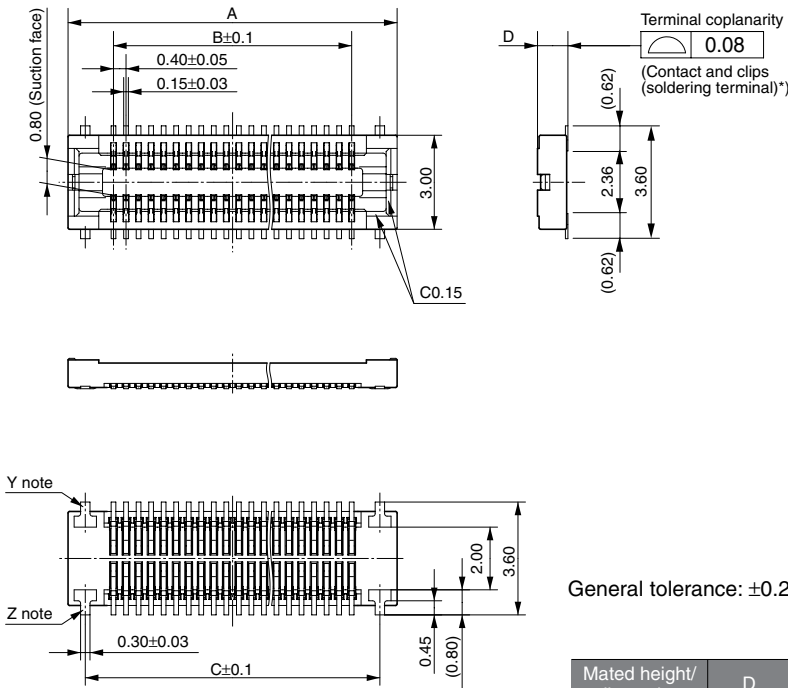
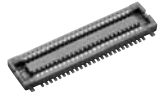

General tolerance: ±0.2

Mated height/ dimension	D
1.0mm	0.97
1.2mm	1.17

Note: Since the clip (soldering terminal)\* has a single-piece construction, sections Y and Z are electrically connected.

## Dimension table (mm)

Number of contacts/ dimension	A	B	C
10	4.5	1.6	3.4
12	4.9	2.0	3.8
14	5.3	2.4	4.2
16	5.7	2.8	4.6
18	6.1	3.2	5.0
20	6.5	3.6	5.4
22	6.9	4.0	5.8
24	7.3	4.4	6.2
26	7.7	4.8	6.6
28	8.1	5.2	7.0
30	8.5	5.6	7.4
32	8.9	6.0	7.8
34	9.3	6.4	8.2
36	9.7	6.8	8.6
38	10.1	7.2	9.0
40	10.5	7.6	9.4
42	10.9	8.0	9.8
44	11.3	8.4	10.2
46	11.7	8.8	10.6
48	12.1	9.2	11.0
50	12.5	9.6	11.4
54	13.3	10.4	12.2
60	14.5	11.6	13.4
64	15.3	12.4	14.2
70	16.5	13.6	15.4
80	18.5	15.6	17.4

## Header (Mated height: 1.0 mm and 1.2 mm)

**CAD Data**

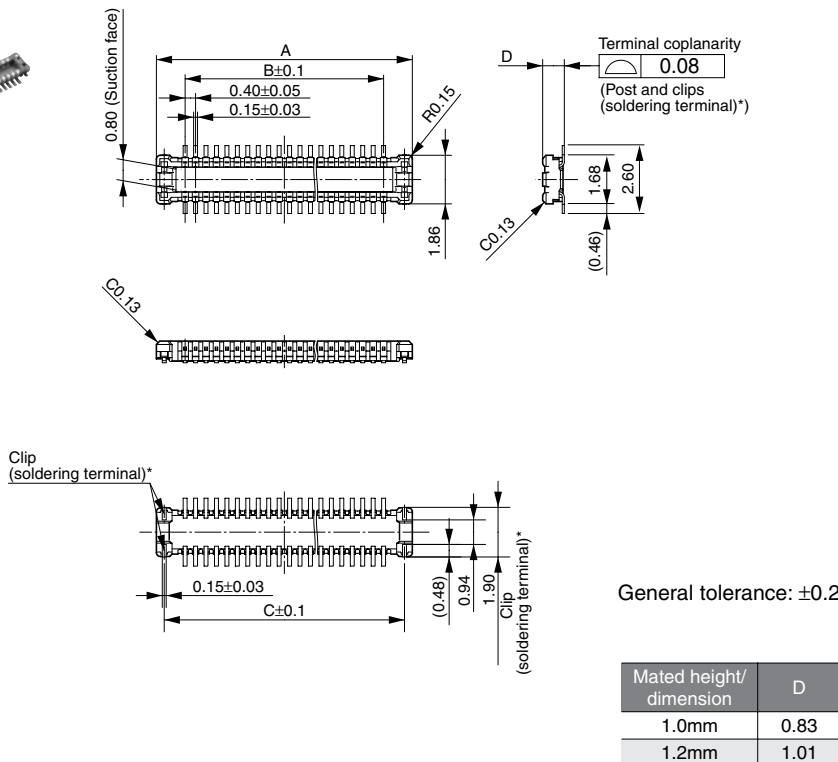

General tolerance: ±0.2

Mated height/ dimension	D
1.0mm	0.83
1.2mm	1.01

## Dimension table (mm)

Number of contacts/ dimension	A	B	C
10	3.8	1.6	3.2
12	4.2	2.0	3.6
14	4.6	2.4	4.0
16	5.0	2.8	4.4
18	5.4	3.2	4.8
20	5.8	3.6	5.2
22	6.2	4.0	5.6
24	6.6	4.4	6.0
26	7.0	4.8	6.4
28	7.4	5.2	6.8
30	7.8	5.6	7.2
32	8.2	6.0	7.6
34	8.6	6.4	8.0
36	9.0	6.8	8.4
38	9.4	7.2	8.8
40	9.8	7.6	9.2
42	10.2	8.0	9.6
44	10.6	8.4	10.0
46	11.0	8.8	10.4
48	11.4	9.2	10.8
50	11.8	9.6	11.2
54	12.6	10.4	12.0
60	13.8	11.6	13.2
64	14.6	12.4	14.0
70	15.8	13.6	15.2
80	17.8	15.6	17.2

## • Socket and Header are mated

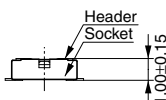

Mated height: 1.0 mm

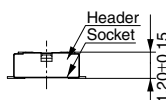

Mated height: 1.2 mm

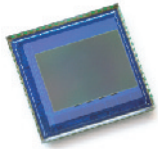

# OV5640 5-megapixel product brief



## 1/4-inch, 5-Megapixel SOC Image Sensor Optimized for High-Volume Mobile Markets



available in  
a lead-free  
package

The OV5640 delivers a complete 5-megapixel camera solution on a single chip, aimed at offering cost efficiencies that serve the high-volume autofocus (AF) camera phone market. The system-on-a-chip (SOC) sensor features OmniVision's 1.4 micron OmniBSI™ backside illumination architecture to deliver excellent pixel performance and best-in-class low-light sensitivity, while enabling ultra compact camera module designs of 8.5 mm x 8.5 mm with <6 mm z-height. The OV5640 provides the full functionality of a complete camera, including anti-shake technology, AF control, and MIPI while being easier to tune than two-chip solutions, making it an ideal choice in terms of cost, time-to-market and ease of platform integration.

The OV5640 enables 720p HD video at 60 frames per second (fps) and 1080p HD video at 30 fps with complete user control over formatting and output data transfer. The 720p/60 HD video is captured in full field of view (FOV) with 2 x 2 binning, which doubles the sensitivity and improves the signal-to-noise ratio (SNR). Additionally, a unique post-binning re-sampling filter function removes zigzag artifacts around slant edges and minimizes spatial artifacts to deliver even sharper, crisper

color images. To further improve camera performance and user experience, the OV5640 features an internal anti-shake engine for image stabilization, and it supports Scalado™ tagging for faster image preview and zoom.

The OV5640 offers a digital video port (DVP) parallel interface and a high-speed dual lane MIPI interface, supporting multiple output formats. An integrated JPEG compression engine simplifies data transfer for bandwidth-limited interfaces. The sensor's automatic image control functions include automatic exposure control (AEC), automatic white balance (AWB), automatic band filter (ABF), 50/60 Hz automatic luminance detection, and automatic black level calibration (ABLC). The OV5640 delivers programmable controls for frame rate, AEC/AGC 16-zone size/position/weight control, mirror and flip, cropping, windowing, and panning. It also offers color saturation, hue, gamma, sharpness (edge enhancement), lens correction, defective pixel canceling, and noise canceling to improve image quality.

Find out more at [www.ovt.com](http://www.ovt.com).

## applications

- cellular phones
- toys
- PC multimedia
- digital still cameras

## ordering information

- OV05640-A71A-1B** (color, lead-free)  
71-pin CSP

## features

- 1.4  $\mu\text{m}$  x 1.4  $\mu\text{m}$  pixel with OmniBSI technology for high performance (high sensitivity, low crosstalk, low noise, improved quantum efficiency)
- optical size of 1/4"
- automatic image control functions: automatic exposure control (AEC), automatic white balance (AWB), automatic band filter (ABF), automatic 50/60 Hz luminance detection, and automatic black level calibration (ABLC)
- programmable controls for frame rate, AEC/AGC 16-zone size/position/weight control, mirror and flip, cropping, windowing, and panning
- image quality controls: color saturation, hue, gamma, sharpness (edge enhancement), lens correction, defective pixel canceling, and noise canceling
- support for output formats: RAW RGB, RGB565/555/444, CCIR656, YUV422/420, YCbCr422, and compression
- support for video or snapshot operations
- support for internal and external frame synchronization for frame exposure mode
- support for LED and flash strobe mode
- support for horizontal and vertical sub-sampling, binning
- support for minimizing artifacts on binned image
- support for data compression output
- support for anti-shake
- standard serial SCCB interface
- digital video port (DVP) parallel output interface and dual lane MIPI output interface
- embedded 1.5V regulator for core power
- programmable I/O drive capability, I/O tri-state configurability
- support for black sun cancellation
- support for images sizes: 5 megapixel, and any arbitrary size scaling down from 5 megapixel
- support for auto focus control (AFC) with embedded AF VCM driver
- embedded microcontroller
- suitable for module size of 8.5 x 8.5 x <6mm with both CSP and RW packaging

## key specifications (typical)

- active array size:** 2592 x 1944
- power supply:**
  - core: 1.425 ~ 1.675V (with embedded 1.5V regulator)
  - analog: 2.6 ~ 3.0V (2.8V typical)
  - I/O: 1.8V / 2.8V
- power requirements:**
  - active: 140 mA
  - standby: 20  $\mu\text{A}$
- temperature range:**
  - operating: -30°C to 70°C junction temperature (see [table 8-2](#))
  - stable image: 0°C to 50°C junction temperature (see [table 8-2](#))
- output formats:** 8-/10-bit RGB RAW output
- lens size:** 1/4"
- lens chief ray angle:** 24° (see [figure 10-2](#))
- input clock frequency:** 6~27 MHz
- max S/N ratio:** 36 dB
- dynamic range:** 68 dB @ 8x gain
- maximum image transfer rate:**
  - QSXGA (2592x1944): 15 fps
  - 1080p: 30 fps
  - 1280x960: 45 fps
  - 720p: 60 fps
  - VGA (640x480): 90 fps
- sensitivity:** 600 mV/Lux-sec
- shutter:** rolling shutter / frame exposure
- maximum exposure interval:** 1964 x  $t_{\text{ROW}}$
- pixel size:** 1.4  $\mu\text{m}$  x 1.4  $\mu\text{m}$
- dark current:** 8 mV/s @ 60°C junction temperature
- image area:** 3673.6  $\mu\text{m}$  x 2738.4  $\mu\text{m}$
- package dimensions:** 5985  $\mu\text{m}$  x 5835  $\mu\text{m}$



Kameraanwendungen

*your BEST camera module partner*



Autopilot



Live-Streaming



Videokonferenz



Biometrische Eye-Tracker-Erkennung

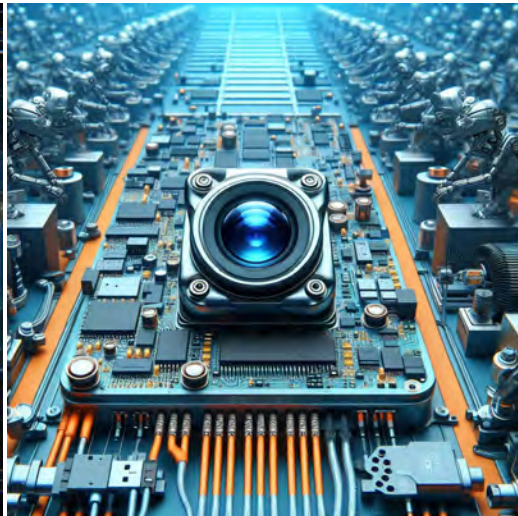

Maschinelles Sehen



Agrarmonitor



Nachtsichtsicherheit



Drohnen- und Sport-Adleraugen



Interaktive Haustierkamera

[www.KaiLapTech.com](http://www.KaiLapTech.com) [sales@KaiLapTech.com](mailto:sales@KaiLapTech.com) Tel: (852) 6908 1256 Fax: (852) 3017 6778



*your BEST camera module partner*

## Kameraanwendungen



### IMAGING DEVICES





Referenztable für die Pinbelegungsdefinition des Kameramoduls

OmniVision Sony Himax Samsung On-Semi Aptina Himax GalaxyCore PixArt Bildsensoren	
Pin Signal	Beschreibung
DGND GND	Masse für digitale Schaltung
AGND	Masse für analoge Schaltung
PCLK DCK	DVP-PCLK-Ausgang
XCLR PWDN XSHUTDOWN STANDBY	Abschalten aktiv hoch mit internem Pulldown-Widerstand
MCLK XVCLK XCLK INCK	Systemeingangsuhr
RESET RST	Aktiv Low mit internem Pull-up-Widerstand zurücksetzen
NC NULL	keine Verbindung
SDA SIO_D SIOD	SCCB-Daten
SCL SIO_C SOIC	SCCB-Eingangstakt
VSYNC XVS FSYNC	DVP-VSYNC-Ausgang
HREF XHS	DVP-HREF-Ausgang
DOVDD	Strom für E/A-Schaltung
AFVDD	Strom für VCM-Schaltung
AVDD	Strom für analoge Schaltung
DVDD	Strom für digitale Schaltung
STROBE FSTROBE	Strobe-Ausgang
FSIN	Synchronisieren Sie das VSYNC-Signal vom anderen Sensor
SID	SCCB letzte Bit-ID-Eingabe
ILPWM	mechanische Shutter-Ausgangsanzeige
FREX	Rahmenbelichtung / mechanischer Verschluss
GPIO	Allzweckeingänge
SLASEL	I2C-Slave-Adresse auswählen
AFEN	CEN-Chip aktivieren aktiv hoch auf VCM-Treiber-IC
<b>MIPI Schnittstelle</b>	
MDN0 DN0 MD0N DATA_N DMO1N	MIPI 1st negative Ausgabe der Datenspur
MDP0 DP0 MD0P DATA_P DMO1P	MIPI 1st positiver Ausgang der Datenspur
MDN1 DN1 MD1N DATA2_N DMO2N	MIPI 2nd negative Ausgabe der Datenspur
MDP1 DP1 MD1P DATA2_P DMO2P	MIPI 2nd positiver Ausgang der Datenspur
MDN2 DN2 MD2N DATA3_N DMO3N	MIPI 3rd negative Ausgabe der Datenspur
MDP2 DP2 MD2P DATA3_P DMO3P	MIPI 3rd positiver Ausgang der Datenspur
MDN3 DN3 MD3N DATA4_N DMO4N	MIPI 4th negative Ausgabe der Datenspur
MDP3 DP3 MD3P DATA4_P DMO4P	MIPI 4th positiver Ausgang der Datenspur
MCN CLKN CLK_N DCKN	MIPI Uhr negativer Ausgang
MCP CLKP MCP CLK_P DCKN	MIPI Takt positiver Ausgang
<b>DVP Parallel Schnittstelle</b>	
D0 DO0 Y0	DVP Datenausgabeport 0
D1 DO1 Y1	DVP Datenausgabeport 1
D2 DO2 Y2	DVP Datenausgabeport 2
D3 DO3 Y3	DVP Datenausgabeport 3
D4 DO4 Y4	DVP Datenausgabeport 4
D5 DO5 Y5	DVP Datenausgabeport 5
D6 DO6 Y6	DVP Datenausgabeport 6
D7 DO7 Y7	DVP Datenausgabeport 7
D8 DO8 Y8	DVP Datenausgabeport 8
D9 DO9 Y9	DVP Datenausgabeport 9
D10 DO10 Y10	DVP Datenausgabeport 10
D11 DO11 Y11	DVP Datenausgabeport 11

## Kamera-Zuverlässigkeitstest

Reliability Inspection Item		Testmethode	Akzeptanzkriterium	
Kategorie	Artikel			
Umwelt	Lager Temperatur	Hoch 60°C 96 Std	Temperaturkammer	Keine anormale Situation
		Niedrig -20°C 96 Std	Temperaturkammer	Keine anormale Situation
	Betriebs Temperatur	Hoch 60°C 24 Std	Temperaturkammer	Keine anormale Situation
		Niedrig -20°C 24 Std	Temperaturkammer	Keine anormale Situation
	Feuchtigkeit	60°C 80% 24 Std	Temperaturkammer	Keine anormale Situation
	Thermischer Schock	Hoch 60°C 0.5 Std Niedrig -20°C 0.5 Std Radfahren rein 24 Std	Temperaturkammer	Keine anormale Situation
Physisch	Falltest (Im freien Fall)	Ohne Verpackung 60cm	10 Mal auf Holzboden	Elektrisch funktionsfähig
		Mit Paket 60cm	10 Mal auf Holzboden	Elektrisch funktionsfähig
	Vibrations Test	50Hz X-Axis 2mm 30 Minuten	Vibrationstisch	Elektrisch funktionsfähig
		50Hz Y-Axis 2mm 30 Minuten	Vibrationstisch	Elektrisch funktionsfähig
		50Hz Z-Axis 2mm 30 Minuten	Vibrationstisch	Elektrisch funktionsfähig
	Zugfestigkeit des Kabels Krafttest	Gewicht laden 4 kg 60 Sekunden Radfahren rein 24 Std	Zugprüfmaschine	Elektrisch funktionsfähig
Elektrisch	ESD-Test	Kontaktaufnahme 2 KV	ESD-Prüfmaschine	Elektrisch funktionsfähig
		Luftentladung 4 KV	ESD-Prüfmaschine	Elektrisch funktionsfähig
	Alterungstest	On/Off 30 Sekunden Radfahren rein 24 Std	Stromschalter	Elektrisch funktionsfähig
	USB-Anschluss	On/Off 250 Mal	Einstecken und ausstecken	Elektrisch funktionsfähig





Inspektionsgegenstand		Untersuchungsmethode	Inspektionsstandard	
Kategorie	Artikel			
Aussehen	FPC oder PCB	Farbe	Das bloße Auge	Größere Unterschiede sind nicht zulässig.
		Zerrissen/gehackt werden	Das bloße Auge	Das Freilegen von Kupferrissen ist nicht zulässig.
		Markierung	Das bloße Auge	Klar, erkennbar (innerhalb von 30 cm Entfernung)
	Halterin	Kratzer	Das bloße Auge	Die Freilegung von Rissen im Inneren ist nicht zulässig
		Lücke	Das bloße Auge	Erfüllen Sie den Höhenstandard
		Schraube	Das bloße Auge	Stellen Sie sicher, dass Schrauben vorhanden sind (falls vorhanden)
		Schaden	Das bloße Auge	Die Freilegung von Rissen im Inneren ist nicht zulässig
	Linse	Kratzen	Das bloße Auge	Keine Auswirkung auf den Auflösungsstandard
		Kontamination	Das bloße Auge	Keine Auswirkung auf den Auflösungsstandard
		Ölfilm	Das bloße Auge	Keine Auswirkung auf den Auflösungsstandard
		Abdeckband	Das bloße Auge	Kein Problem beim Aussehen.
	Funktion	Bild	Keine Kommunikation	Testboard
Helles Pixel			Tafel	Im Image Center nicht erlaubt
Dunkles Pixel			Weißer Tafel	Im Image Center nicht erlaubt
Verschwommen			Das bloße Auge	Nicht erlaubt
Kein Bild			Das bloße Auge	Nicht erlaubt
Vertikale Linie			Das bloße Auge	Nicht erlaubt
Horizontale Linie			Das bloße Auge	Nicht erlaubt
Kleines Leck			Das bloße Auge	Nicht erlaubt
Blinkendes Bild			Das bloße Auge	Nicht erlaubt
Prellung			Inspektionslehre	Nicht erlaubt
Auflösung			Diagramm	Folgt dem Diagrammstandard für ausgehende Inspektionen
Farbe			Das bloße Auge	Kein Problem
Lärm			Das bloße Auge	Nicht erlaubt
Ecke dunkel			Das bloße Auge	Weniger als 100 x 100 Pixel
Farbauflösung			Das bloße Auge	Kein Problem
Abmessungen	Höhe	Das bloße Auge	Follows Approval Data Sheet	
	Breite	Das bloße Auge	Follows Approval Data Sheet	
	Länge	Das bloße Auge	Follows Approval Data Sheet	
	Gesamt	Das bloße Auge	Follows Approval Data Sheet	



## KLT-Paketlösungen

KLT Kameramodul



Komplett mit Linsenschutzfolie



Tablett mit Gitter und Raum



Legen Sie die Kameras auf das Tablett



## Paketlösung für Kameramodule

Volles Tablett mit Kameras



Abdeckschale mit Deckel



In Antistatikbeutel stecken



Staubsaugen Sie den antistatischen Beutel





## Paketlösung für Kameramodule

Versiegelter Vakuumbbeutel mit Etiketten

1. Modell und Beschreibung 2. Menge 3. Versanddatum 4. Achtung



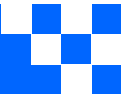

## Paketlösung für große Bestellungen

Schaumstoffplatten zwischen  
die Tablettts legen



Schaumstoffplatten sind etwas  
größer als Tablettts



Legen Sie Schaumstoffplatten und  
Tablettts in die Schachtel



Schaumstoffplatten sind eng anliegende Box





## Paketlösung für kleine Bestellungen

Legen Sie die Schaumstoffplatten und  
Tablets in die kleine Schachtel



Schaumstoffplatten passen gut in  
die kleine Box



Paket in kleiner Box für den Versand



Legen Sie kleine Kartons in größere Kartons





## Carbon Box Paketlösung

Verschließen Sie die Carbonbox

Beschriftete Schachtel mit Endverpackung



### Versandfertige Karbonbox

1. Lieferadresse und Telefonnummer
2. Box-Nr. und Versanddatum
3. Zerbrechliche Vorsicht



## Lösung für Musterbestellungspakete

Legen Sie die Probe in einen kleinen antistatischen Beutel



Stecken Sie die Anschlüsse in den kleinen antistatischen Beutel



### Musteretiketten auf dem kleinen Beutel

1. Kameramodul oder Anschlussmodell 2. Lieferdatum und Menge 3. Achtung





## Connectors Large Order Package Solution

Steckverbinder in einem Rad



Steckverbinder im Rad beschriften



Das Rad passt perfekt in die Box



Steckerbox versandfertig



**Unternehmen Kai Lap Technologies (KLT)**

Kai Lap Technologies Group Limited. (KLT) wurde 2009 gegründet und ist ein technologiegetriebener Hersteller der nächsten Generation, der sich auf Forschung, Design und Produktion von Audio- und Videoprodukten spezialisiert hat. KLT verfügt über 20.000 Quadratfuß automatisierte Fabriken mit 100 Mitarbeitern und einem jährlichen Durchsatz von 30.000.000 Kameraeinheiten.

KLT bietet OEM-, ODM-Design, Auftragsfertigung und baut die Kameraprodukte. Sie können uns die Anforderungen auch mit einem Handentwurf übermitteln, unser Vertrieb und unsere Technik arbeiten zusammen, um Ihre Anforderungen zu erfüllen. Wir verstehen uns als Ihr langfristiger Partner bei der Entwicklung praktischer und innovativer Lösungen.

Unser Team deckt alles von der ersten Konzeptentwicklung bis zum Massenprodukt ab. KLT ist spezialisiert auf kundenspezifisches Kameradesign, Rohmaterial, Elektrotechnik, Firmware-/Softwareentwicklung, Produkttests und Verpackungsdesign. Unsere erfahrenen strategischen Versorgungssysteme bieten eine robuste und zuverlässige Fertigungskapazität für Aufträge unterschiedlicher Größe.

**Eingeschränkte Garantie**

KLT gewährt die folgende eingeschränkte Garantie, wenn Sie das/die Produkt(e) direkt von der Firma KLT oder von der Website von KLT, [www.KaiLapTech.com](http://www.KaiLapTech.com), gekauft haben. Produkte, die von anderen Verkäufern oder Quellen gekauft wurden, fallen nicht unter diese beschränkte Garantie. KLT garantiert, dass das/die Produkt(e) bei normalem Gebrauch für einen Zeitraum von einem (1) Jahr ab dem Datum, an dem Sie das Produkt erhalten („Garanzzeitraum“), frei von Material- und Verarbeitungsfehlern sind.

Für alle Produkte, die während des Garanzzeitraums Material- oder Verarbeitungsfehler enthalten oder entwickeln, wird KLT nach eigenem Ermessen entweder: (i) die Produkte reparieren; (ii) das/die Produkt(e) durch ein neues oder generalüberholtes Produkt(e) ersetzen (Ersatzprodukt(e) sind von identischem Modell oder funktionell gleichwertig); oder (iii) Ihnen den Preis erstatten, den Sie für das/die Produkt(e) gezahlt haben.

Diese eingeschränkte Garantie von KLT ist ausschließlich auf Reparatur und/oder Ersatz zu den oben genannten Bedingungen beschränkt. KLT ist nicht zuverlässig oder verantwortlich für nachfolgende Ereignisse.





# CMOS CAMERA MODULES



*your BEST camera module partner*

## KLT Stärke

Leistungsstarke Fabrik



## Professioneller Service



## Versprochene Lieferung



[www.KaiLapTech.com](http://www.KaiLapTech.com) [sales@KaiLapTech.com](mailto:sales@KaiLapTech.com) Tel: (852) 6908 1256 Fax: (852) 3017 6778

All rights reserved @ Kai Lap Technologies Group Ltd. Specifications subject to change without notice.